

CEILING | SYSTEMS

Between us, ideas become reality™

**METALWORKS™ Vector®
and Vector Exterior**

Armstrong®

METALWORKS™

Vector® & Vector Exterior

smooth texture



MetalWorks Vector Exterior in Silver Grey with Prelude® XL® suspension system for Exterior Applications; RTC Bonneville Transit Center, Las Vegas, NV

Key Selection Attributes

- Exclusive Vector-edge profile ceiling installs on new or existing 15/16" exposed tee suspension system resulting in a thin 1/4" reveal
- Outstanding NRC with acoustical fleece or infill panel (0.65 – 0.90)
- Durable – Washable, Scrubbable, Impact-resistant, Soil-resistant
- Exterior system available, tested to meet wind uplift Classes 30, 60, and 90; less expensive than stucco for exteriors
- BioAcoustic™ infill panels can enhance acoustics and contribute to LEED® Credits
- Installs with minimal plenum clearance
- Standard edge caps for cut panels available in White, Silver Grey, Gun Metal Grey, and Black (for use with Effects™ colors)
- 100% downward accessible, without tools, plenum access per panel without the need of special tools
- For additional sizes, colors, and perforations, contact the Architectural Specialties project management team at 1 877 ARMSTRONG and select options 1-1-4



MetalWorks Vector Faceted Extra Microperforated in Effects Wood Looks Dark Cherry; Mount Saint Mary College, Newburgh, NY

Color Selection Due to printing limitations, shade may vary from actual product.

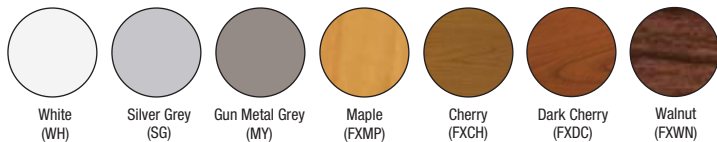

White Exterior (WH2)	Silver Grey Exterior (SG2)	Gun Metal Grey Exterior (MY2)	Effects Maple Exterior (FXMP2)	Effects Cherry Exterior (FXCH2)	Effects Dark Cherry Exterior (FXDC2)	Effects Walnut Exterior (FXWN2)
----------------------	----------------------------	-------------------------------	--------------------------------	---------------------------------	--------------------------------------	---------------------------------

Panels are also available in Custom RAL colors upon request.
NOTE: Effects colors are only available for items 6466M1 and 6466M3.

Perforation Options (Actual 1:2 scale shown)

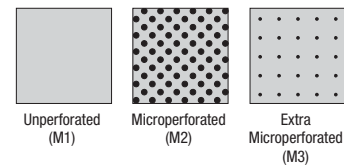

Detail



On the cover: MetalWorks Vector Microperforated in White with Prelude grid in White Financial institution, Boston, MA

Additional sizes, colors, and perforations available as custom options. For more information, visit our web site at armstrong.com/metalworks or call 1 877 ARMSTRONG and select options 1-1-4 to work with the Architectural Specialties project management team.

Recycled Content: 25%

armstrong.com/greengenie

LEED® Credits

Energy	Waste Mgmt	Recycled Content	Local Materials	Renewable Materials	Daylight & Views
	✓	✓	✓		
Location Dependent					

LEED for Schools

Acoustics	Low Emitting or CHPS
✓	✓

Colors and Perforations

White (WH)	Effects Cherry (FXCH)	Silver Grey Exterior (SG2)	Effects Dark Cherry Exterior (FXDC2)	Unperforated (M1)
Silver Grey (SG)	Effects Dark Cherry (FXDC)	Gun Metal Grey Exterior (MY2)	Effects Walnut Exterior (FXWN2)	Microperforated (M2)
Gun Metal Grey (MY)	Effects Walnut (FXWN)	Effects Maple Exterior (FXMP2)		Extra Microperforated (M3)
Effects™ Maple (FXMP)	White Exterior (WH2)	Effects Cherry Exterior (FXCH2)		

Visual Selection

Performance Selection Dots represent highest level of performance.

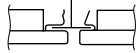
Edge Profile	Item Number*	Dimensions	% Open Area	Acoustics		Light Reflect (White only)	Durable			
				NRC	CAC		Wash	Scrub	Impact	Soil
METALWORKS™ Vector® (with acoustical fleece)										
1/4" Reveal with 15/16" Vector	6466M1_-----♦♦	2' x 2' □	0%	0.10	36	0.77	•	•	•	•
	6466M2_-----	2' x 2' □	18.4%	0.70 0.90**	31*	0.61	•	•	•	•
	6466M3_-----♦♦	2' x 2' □	1.5%	0.65 0.70**	33*	0.77	•	•	•	•

- ♦ When specifying or ordering, include the appropriate letter color suffix with the item number (e.g., 6466 M 1 W H, 6466 M 3 E X C H, or 6466 M 1 E X M P 2). Light reflectance is for White only.
 - ♦♦ Available in Effects Wood Looks finishes. NOTE: Perforation M2 is not available in Effects finishes as a standard option and has a 1,000 SF minimum order quantity.
 - * With optional field-cut #770 mineral fiber backing (cannot be used with fiberglass infill #8200100).
 - ** NRC 0.90 (microperforated); NRC 0.70 (extra microperforated) with optional fiberglass infill #8200100 (cannot be used with #770 mineral fiber backing) NRC 0.85 (microperforated); or NRC 0.70 (extra microperforated) with optional BioAcoustic™ infill #5479 or 5823.
- NOTE: Acoustical fleece on interior perforated panels only.

Suspension Systems

15/16"	Prelude® XL®
15/16"	Prelude XL for Exterior Applications† 12' Main Beam: 7301G90 2' Cross Tee: XL7321G90 10' Wall Molding: HD7801G90

† Available in Silver Grey (SG) and Gun Metal Grey (MY) colors as special order.

Installation Details



Panel Details

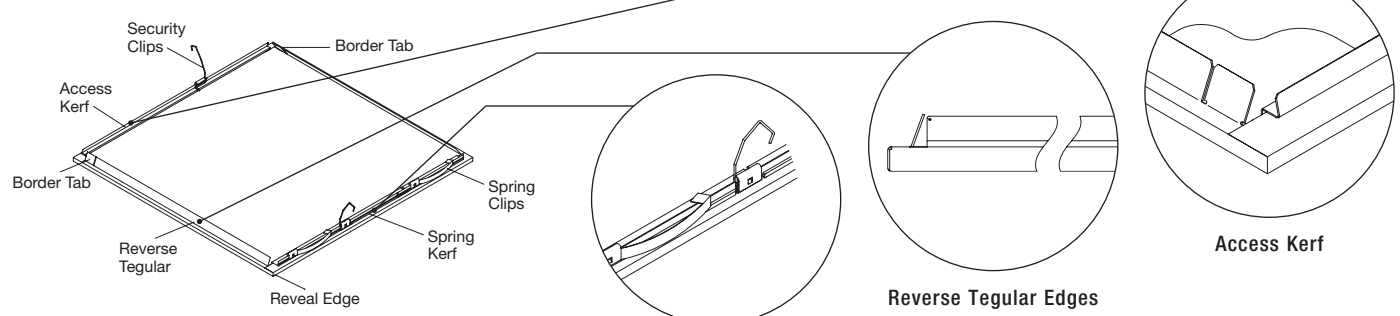

MetalWorks Vector Panel Detail

Spring Kerf

Reverse Tegular Edges

Access Kerf

METALWORKS™

Vector® & Vector Exterior

smooth texture

Colors	
White (WH)	Effects™ Maple (FXMP)
Silver Grey (SG)	Effects Cherry (FXCH)
Gun Metal Grey (MY)	Effects Dark Cherry (FXDC)
Black (BL)	Effects Walnut (FXWN)

Accessories

Item Number	Description	Dimensions	Pieces/Carton
AX2STR	Axiom® Classic Trim - 2" Straight	120" x 3/4" x 2"	–
AX4STR	Axiom Classic Trim - 4" Straight	120" x 3/4" x 4"	–
AX6STR	Axiom Classic Trim - 6" Straight	120" x 3/4" x 6"	–
5342__♦†	2" Effects Wood Looks Trim	Nominal 10' length	6
5344__♦†	4" Effects Wood Looks Trim	Nominal 10' length	6
5346__♦†	6" Effects Wood Looks Trim	Nominal 10' length	6
FXVTBC	Vector T-Bar Connector Clip	N/A	10
FXSPTHDC	Effects Hold Down Clip for Cut Panel Installations	N/A	10
84008_♦	Vector Single-Slot Air Diffuser	2' x 2' (not available in Effects colors)	1
6098_♦	Edge Cap for Cut Panels	Nominal 2' length panels – use Black (BL) for Effects colors	50
5479	BioAcoustic™ Infill Panel (Beige Matte)	2' x 2' x 5/8"	12
5823	BioAcoustic Infill Panel (Black Matte)	2' x 2' x 5/8"	12
770**	Cortega® Square Lay-in Panel (White or Black Matte)	2' x 2' x 5/8"	8
8200100	1" Fiberglass Infill Bag (Black Gloss)	2' x 2' x 1"	12

♦ When specifying or ordering, include the appropriate two- or four-letter color suffix with the item number (e.g., 6098 W H or 5342 E X C H).

** Recommended for high CAC acoustical performance with MetalWorks Extra Microperforated panels.

† NOTE: Effects Wood Looks Trim cartons include FXSPICE plates and FXTBC clips. For more information about Effects or Axiom trim options, visit armstrong.com/trim

Accessory Details

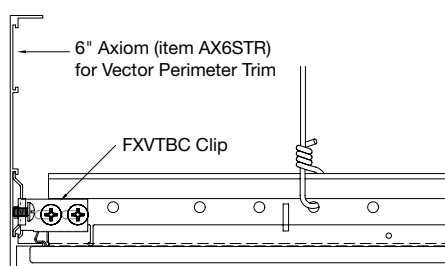

Axiom Classic Trim Application

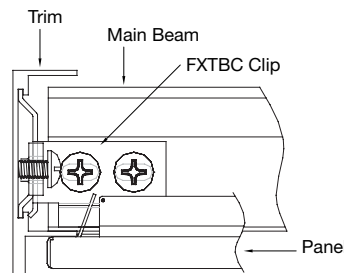

Effects Trim Application

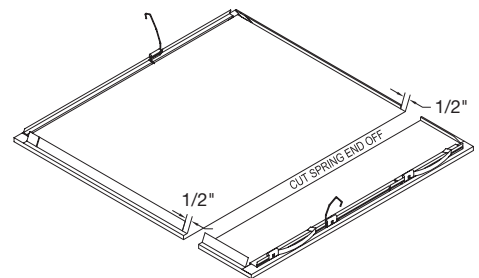

Cutting MetalWorks Panel for Edge Cap

Physical Data

Material

Electrogalvanized Steel – 0.021" thickness

Surface Finish

Factory-applied powder-coated finish (post-coated).
Exterior: Factory-applied powder-coated finish (post-coated on both sides). Effects finish on face only. Premium and Custom RAL colors also available. Refer to CS-3957 for a sampling of Custom RAL colors. Contact Armstrong Architectural Specialties for custom color matching requests at 1 877 ARMSTRONG, select options 1-1-4.

Fire Performance

Factory Mutual Approvals Specification tested per ASTM E84 and CAN/ULC S102. Flame Spread Index 25 or less. Smoke Developed Index 50 or less.

ASTM E1264 Classification

Fire Class – Class A
Unperforated – Type XX, Pattern G
Perforated – Type XX, Pattern C

Installation Consideration

For information about accessible faceted applications, refer to installation instructions on our web site at armstrong.com/installation.

Seismic Installations

MetalWorks Vector has been engineered, tested, and approved for application in all seismic areas.

Wind Uplift Performance

MetalWorks Vector for exterior applications has been tested to meet wind uplift Classes 30, 60, and 90. Visit armstrong.com/metalworks or contact TechLine at 1 877 ARMSTRONG for installation instructions and test documentation.

Warranty

One (1) year limited warranty. Details: armstrong.com/warranty

Weight; Square Feet/Carton

6466M1, 6466M3 – 1.15 lbs/SF; 40 SF/ctn
6466M2 – 1.10 lbs/SF; 40 SF/ctn