



CEILING & WALL SYSTEMS

WOODWORKS® Linear
Veneered Planks and Panels
Solid Wood Panels

- Three different ways to achieve a linear look
- Choose traditional planks, or fast, easy-to-install panels
- Unique, new tapered visual available on veneered panels
- FSC® Certified: products represent responsible production and consumption practices from the forest to the consumer
- Shorter lead times and lower cost than custom millwork
- Custom veneers and stain matching available



WOODWORKS® Linear – Planks

Natural Variations™, Constants™, & Bamboo



WoodWorks Linear 8' x 3-3/4" in Custom Constants Light Cherry; Fox Lake District Library, Fox Lake, IL

Additional Attributes of WoodWorks Linear Planks

- Standard wood plank in 2 widths; nominal 4-1/2" and 6" modules, with traditional 3/4" reveals
- Standard factory-applied acoustical fleece
- Install in the ceiling, on the wall, or create 90° angled or curved ceiling-to-wall transitions (one-foot minimum radius)
- Create upturns for continuous visuals and clouds with veneer-wrapped WoodWorks Trim
- Suspension system and planks from one manufacturer; improved for 30-50% faster installation
- California Air Resources Board (CARB) compliant
- 100% Biobased content certified by USDA BioPreferred® Products program (preferred for government projects)
- Class A Fire Resistance
- Custom veneers and stain matching available; for details, contact Architectural Specialties at 1 877 ARMSTRONG, select options 1-1-4



WoodWorks Linear 3-3/4" Ceiling System in Natural Variations Maple; Custom Installation at NaviNet, Inc., Boston, MA

Veneer Selection Due to printing limitations, shade may vary from actual product.

Natural Variations (Real Wood Veneers)

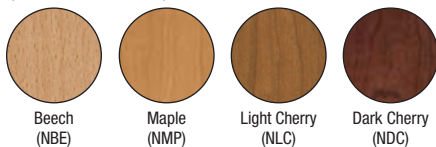

Constants (Real Wood Veneers)



Bamboo (Rapidly Renewable)

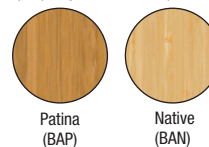

You can also create beautiful curved looks with a faceted suspension system. Due to its non-standard suspension system, these S-Service items are ordered through Architectural Specialties at 1 877 ARMSTRONG, select options 1-1-4.

Cover Photo: WoodWorks Linear Ceiling System in Natural Variations Light Cherry; Fine Fissured™ Square Lay-in on Prelude® XL® suspension system; Side Street Inn, Honolulu, HI

WOODWORKS® Linear – Planks



Natural Variations™, Constants™, & Bamboo

Colors

NV Beech (NBE)	NV Dark Cherry (NDC)	Constants Walnut (CWA)
NV Maple (NMP)	Constants Maple (CMA)	Bamboo Patina (BAP)
NV Light Cherry (NLC)	Constants Cherry (CCY)	Bamboo Native (BAN)

Linear Planks Visual Selection

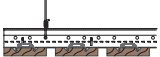
Performance Selection Dots represent highest level of performance

Edge Profile	Item Number *	Dimensions	Acoustics NRC 	Fire Rating
WOODWORKS Linear – Nominal 4-1/2" Module				
	6440W1_ _ _	8' x 3-3/4" x 3/4" with 3/4" reveal	0.50 0.65** ●	Class A
	6640W1_ _ _ (FSC®-certified)	8' x 3-3/4" x 3/4" with 3/4" reveal	0.50 0.65** ●	Class A
WOODWORKS Linear – Nominal 6" Module				
	6460W1_ _ _	8' x 5-1/4" x 3/4" with 3/4" reveal	0.40 0.50**	Class A
	6660W1_ _ _ (FSC-certified)	8' x 5-1/4" x 3/4" with 3/4" reveal	0.40 0.50**	Class A

* When specifying or ordering, please include the appropriate three-letter color suffix (e.g., 6460W1 **N M P**)

** Adding acoustical infill (item 8200100, 5479, or 5823) for 4-1/2" module increases the NRC to 0.65. Adding acoustical infill (8208100, 5479, 5823) for 6" module increases the NRC to 0.50.

Suspension System

Item Number	Description	Dimensions	Pieces/Carton
5370	12' HD Linear Carriers (concealed) with integral clips (factory-applied) for nominal 4-1/2" modules	12' x 15/16" x 1-11/16"	10 (Approx. 240 SF/ctn installed with planks)
5371	12' HD Linear Carriers (concealed) with integral clips (factory-applied) for nominal 6" modules	12' x 15/16" x 1-11/16"	10 (Approx. 240 SF/ctn installed with planks)

Note: For radiused applications, use standard panels and HD Linear Carriers faceted 12" on center with RC2BL clips.

Ceiling-to-Wall Transitions



WoodWorks Linear 8' x 3-3/4" in Natural Variations Light Cherry; Ceiling-to-Wall Faceted Transition



WoodWorks Linear 8' x 3-3/4" in Natural Variations Light Cherry; Ceiling-to-Wall 90° Angle Transition

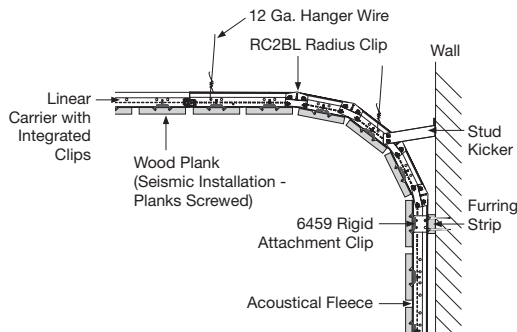

Faceted Ceiling-to-Wall System Assembly

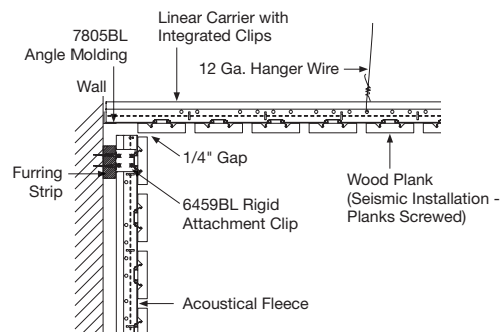

90° Ceiling-to-Wall System Assembly

WOODWORKS® Linear – Planks

Natural Variations™, Constants™, & Bamboo

Recycled Content: 92%

armstrong.com/greengenie

LEED® Credits

Energy	Waste Mgmt	Recycled Content	Local Materials	Renewable Materials	Certified Wood*	Low Emitting*
✓	✓	✓	✓	✓	✓	✓
		Location Dependent			*Options Available	

LEED for Schools

Acoustics	Low Emitting or CHPS
✓	✓

Colors

NV Beech (NBE)	NV Dark Cherry (NDC)	Constants Walnut (CWA)
NV Maple (NMP)	Constants Maple (CMA)	Bamboo Patina (BAP)
NV Light Cherry (NLC)	Constants Cherry (CCY)	Bamboo Native (BAN)

Accessories

Item Number	Description	Dimensions	Pieces/Carton
5843	Linear Wood Panel Splice	—	100
5659W1 _ _ _ ♦	4" WoodWorks Trim (with aluminum substrate)	4" x 10'	6
5660W1 _ _ _ ♦	6" WoodWorks Trim (with aluminum substrate)	6" x 10'	6
5948	Linear and Channeled Trim Connector Clip	N/A	30
RC2BL	Radius Clip for faceted suspension system applications (Black)	—	205 pcs/bucket
7805BL**	10' Angle Molding (Tech Black)	10' x 1-1/2" x 1-1/2"	30
7823BL**	10' Shadow Molding (Tech Black)	10' x 2" x 1-1/4" x 3/4"	10
FXSPLICE	Splice Plate with Setscrews for Trim	N/A	10
6408 _ _ _ ♦	3/4" Edge Banding (factory-applied available upon request)	3/4" x 25'	25 foot roll
6459BL	Rigid Attachment Clip (Black)	5-1/2" x 1-3/4"	25
92715A620	Self-tapping Screws (Black)	#2 x 3/4" Length	25
7891	12 Gauge Hanger Wire	12' Length	140
8200100	Fiberglass Infill Bag (Black - Gloss)	2' x 2' x 1'	12
5479	BioAcoustic™ Infill Panel (Beige - Matte)	2' x 2' x 5/8"	12
5823	BioAcoustic Infill Panel (Black - Matte)	2' x 2' x 5/8"	12

♦ When specifying or ordering, include the appropriate three-letter color suffix that coordinates with your WoodWorks ceiling (e.g., 5659W1 B A P)

** This color is a special order item with these moldings.

Linear Planks Accessory Details

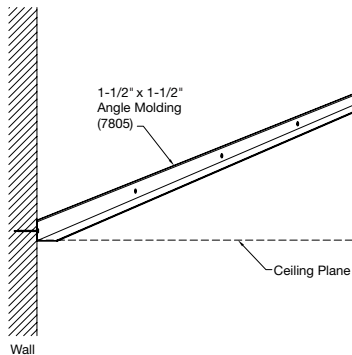

Angle Molding (Item 7805BL) Detail

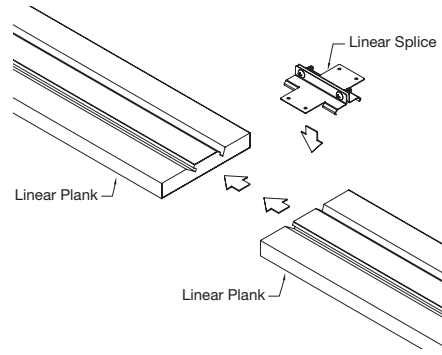

Linear Splice (Item FXSPLICE) Detail

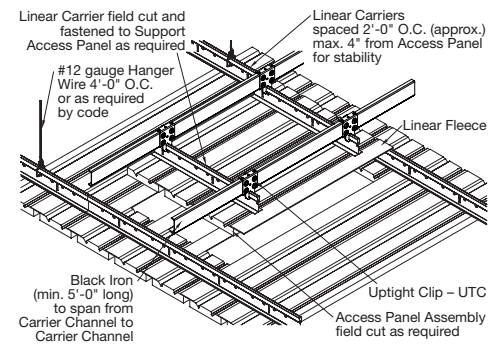

Access Panel Assembly

Linear Planks Physical Data

Material

Fire retardant particle board with face-cut veneers. FSC®-certified fire retardant particle board with face-cut veneers (SW-C0C-3601). For more information about FSC-certified products or to view our FSC certification letter, visit armstrong.com/woodworks/fsc. Factory-applied black fleece on each plank to cover the reveal.

Surface Finish

Clear or tinted semigloss coating

Fire Performance

ASTM E84 surface burning characteristics, HPVA Certified with audit program per ASTM E84. Flame Spread Index 25 or less. Smoke Developed Index 50 or less.

CAN/ULC S102 surface burning characteristics. Flame Spread Rating 25 or less. Smoke Developed Classification 50 or less.

Linear wood, as with other architectural features located at the ceiling, may obstruct or skew the planned fire sprinkler water distribution pattern,

or possibly delay or accelerate the activation of the sprinkler or fire detection systems by channeling heat from a fire either toward or away from the device. Designers and installers are advised to consult a fire protection engineer, NFPA 13, and local codes for guidance where automatic fire detection and suppression systems are present.

ASTM E1264 Classification

Composite – Fire Class A

Seismic Restraint

Linear wood has been engineered, tested, and approved in all seismic areas.

Design Consideration

WoodWorks Linear panels are edge banded on the long sides but unfinished on the short ends to make splicing the planks easier. Finished ends are available upon request.

Application Considerations

Variation among panels may occur due to the natural characteristics of the wood and grain.

It is very important that WoodWorks planks are climatized prior to installation. Relative humidity between 25% and 55% and temperatures between 50°F and 86°F must be maintained.

Installation Considerations

Installation can use staggered, random joints for a monolithic appearance or consistent lengths for a modular style. For expansion, a 3/4" gap is recommended at every 24 foot run of plank. See installation instructions LA-297443 at armstrong.com/installation.

Specification Consideration

Attention: For FSC-certified wood products to maintain their CoC certification, products must be sold to a CoC-certified distributor or directly to the installing contractor. Failure to do so breaks the CoC.

Warranty

One (1) year limited warranty. Details: armstrong.com/warranty

Weight/Square Feet

6440, 6640 – 2.88 lbs/SF
6460, 6660 – 2.89 lbs/SF
(Bulk packaged)



The mark of responsible forestry

WOODWORKS® Linear – Panels

Natural Variations™, Constants™, & Bamboo

Additional Attributes of WoodWorks Linear Veneered Panels

- Unique tapered planks or traditional wood planks in nominal 4" or 6" width
- Create continuous looks and clouds with veneer-wrapped and painted aluminum trim
- Hook-on panels (for standard 15/16" suspension) provide safe and secure downward accessibility
- Complete standard system from one manufacturer (grid/panels/trim)
- Factory edge banded for superior quality
- California Air Resources Board (CARB) compliant
- 100% Biobased content certified by USDA BioPreferred® Product program
- BioAcoustic™ infill available for increased acoustical performance
- Acoustical fleece available as an option
- Class A Fire Resistance

Veneer Selection

Due to printing limitations, shade may vary from actual product.

Natural Variations

(Real Wood Veneers)



Beech (NBE)

Maple (NMP)

Light Cherry (NLC)

Dark Cherry (NDC)

Constants

(Real Wood Veneers)



Maple (CMA)

Cherry (CCY)

Walnut (CWA)

Bamboo

(Rapidly Renewable)



Patina (BAP)

Native (BAN)



WoodWorks Linear Veneer panels in tapered visual and Natural Variations Light Cherry finish.

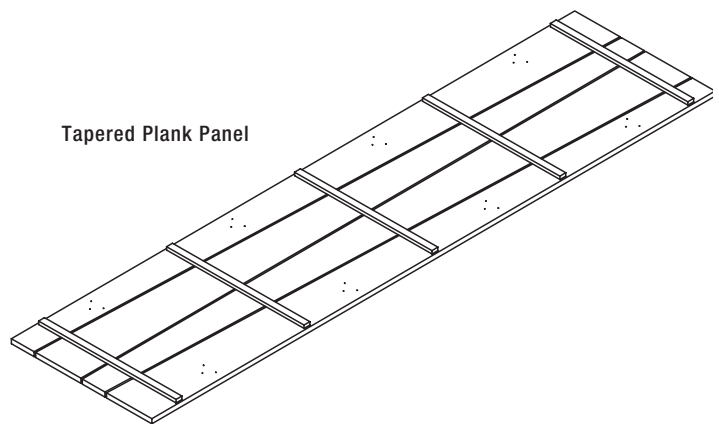

Tapered Plank Panel

In addition to these standard options, there may be other sizes and veneers available. Contact the Armstrong Architectural Specialties project management team for details at 1 877 ARMSTRONG and select options 1-1-4.

WOODWORKS® Linear – Panels

Natural Variations™, Constants™, & Bamboo

Recycled Content: **86%**

armstrong.com/greengenie

LEED® Credits

Energy	Waste Mgmt	Recycled Content	Local Materials	Renewable Materials	Certified Wood*	Low Emitting*
✓	✓	✓	✓	✓	✓	✓
		Location Dependent *			Options Available	



LEED for Schools

Acoustics	Low Emitting or CHPS
✓	✓

Colors

NV Beech (NBE)	NV Dark Cherry (NDC)	Constants Maple (CMA)
NV Maple (NMP)	Bamboo Patina (BAP)	Constants Cherry (CCY)
NV Light Cherry (NLC)	Bamboo Native (BAN)	Constants Walnut (CWA)

Visual Selection

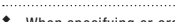
Edge Profile	Item Number*	Description	Dimensions† Nominal W x L x H	NRC**
FSC®-certified WOODWORKS Linear Veneered Panels				
	6690W1 _ _ _	Nominal 4" wide planks	2' x 8' x 3/4"	0.45
	6691W1 _ _ _	Nominal 6" wide planks	2' x 8' x 3/4"	0.20
	6692W1 _ _ _	Tapered planks	2' x 8' x 3/4"	0.20

* When specifying or ordering, include the appropriate three-letter color suffixes.

For veneers, sizes, and perforation patterns available as special order, call 1 877 ARMSTRONG and select options 1-1-4. To view more perforation information and build swatches in real time, visit armstrong.com/swatchit.

** NRC achieved with BioAcoustic™ infill (item 6657).

† Item 6690 – Features a total of 5 planks that are 4.05" wide with a 3/4" reveal between planks. Panels will have a 3/4" reveal on all sides and ends.
 Item 6691 – Features a total of 4 planks that are 5.75" wide with a 3/4" reveal between planks. Panels will have a 3/4" reveal on all sides and ends.
 Item 6692 – Features a total of 4 planks that are 3.833" at one end and 7.666" at the other with a 1/4" reveal between planks and 1/4" reveal on all sides and ends.

Suspension System

15/16" Standard: Prelude® BL (Tech Black)

Item Number	Description	Dimensions	Pieces/Carton
5986	T-Bar Hook [†]	Nominal 4" x 2" x 3"	50
91070A244	Wood Screws	5/8"	100
6091	Safety Cable	24" x 3/32"	50
SH12	Support Hanger	12' x 2"	12

† For 2' x 8' panel, install 8 hooks. Note: Three screws per hook.

Note: Refer to installation instructions at armstrong.com/installation for a better understanding of suspension requirements.

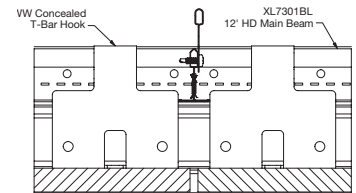

Installation Detail

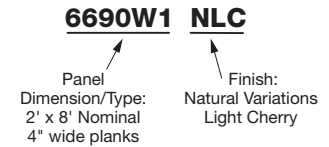

Accessories

Item Number	Description	Dimensions Nominal	Color	Pieces/Carton
6603W1 _ _ _	WoodWorks Concealed Trim**	6" x 10'	Standard Veneers (see above)	6
FXTBC	T-Bar Connector Clip	N/A	N/A	10
FX4SPLICE	Splice Plate with Setscrews	N/A	N/A	10
5823	BioAcoustic™ Infill Panel	2' x 2' x 5/8"	Black	12
6408 _ _ _*	Edge Banding	25' x 3/4"	Standard Veneers (see above)	1

* When specifying or ordering, include the two- or three-letter color suffix that coordinates with your WoodWorks ceiling (6408 **N M P**)

** Trim cartons include FXTBC Clips and FX4SPLICE Plates.

Linear Veneered Panels Physical Data

Material

FSC-certified fire retardant particle board with face-cut veneers (SW-COC-003601). For more information about FSC-certified products or to view our FSC certification letter, visit armstrong.com/woodworksfsfsc

6603 – Face-cut veneer or black paint on aluminum laminate substrate

Surface Finish

Clear or tinted semigloss coating

Fire Performance

ASTM E84 surface burning characteristics, HPVA Certified with audit program per ASTM E84. Flame Spread Index 25 or less. Smoke Developed Index 50 or less.

CAN/ULC S102 surface burning characteristics. Flame Spread Rating 25 or less. Smoke Developed Classification 50 or less.

ASTM E1264 Classification

Composite – Fire Class A

Design Considerations

Cloud installations with total panel width less than 6' wide are not recommended.

Cloud installations with total panel length less than 16' wide cannot be done.

Application Considerations

Variation among panels may occur due to the natural characteristics of the wood and grain.

Use of large wood panels may result in deflection up to 1/8" and alignment inconsistency due to size and ambient conditions.

It is very important that WoodWorks panels are climatized prior to installation. Relative humidity between 25% and 55%, and temperatures between 50°F and 86°F must be maintained throughout the life of the product.

Specification Consideration

Attention: For FSC-certified wood products to maintain their CoC certification, products must be sold to a CoC-certified distributor or directly to the installing contractor. Failure to do so breaks the CoC.

Seismic Installation

These systems have been engineered, tested, and meet the requirements for applications in Seismic Design Categories D, E, and F.

Warranty

One (1) year limited warranty. Details: armstrong.com/warranty

Weight/Square Feet

6690, 6691, 6692 – 2.75 lbs/SF; bulk packed per order. Suspension, hardware, and accessories ordered separately.

WOODWORKS® Linear – Panels

Natural Variations™, Constants™, & Bamboo

How to Install WoodWorks Linear Veneered Panels

Step 1: Select Panel

Pre-drilled holes for T-Bar Hooks

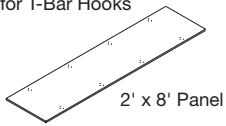

Step 2: Order T-Bar Hooks and Screws Based on Panel Size

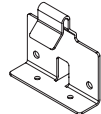

Panel Size	Number of Hooks Needed	Number of Screws Needed*
2' x 8'	8	24
*3 screws per hook		

Step 3: Install Hooks on Panels

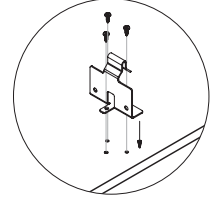

Step 4: Install Panels

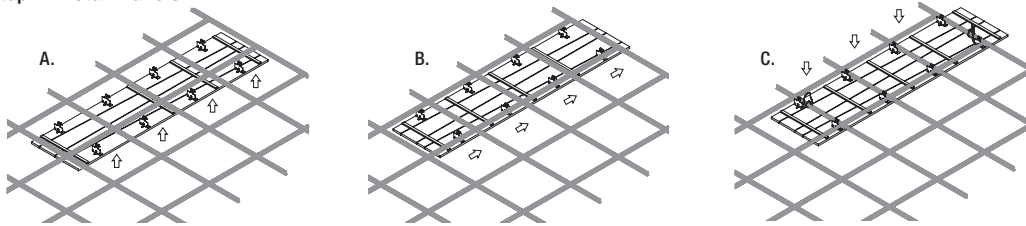

How to Install Trim

Step 1: Cut and Miter Trim

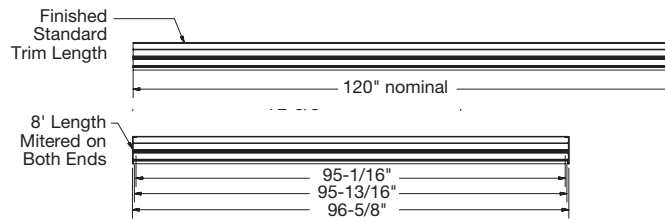
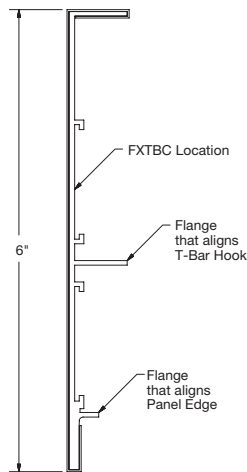

Step 2: Attach Clips to Ends of Main Beams and Cross Tees

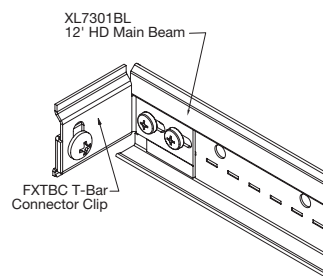

Step 3: Attach Trim to Clips

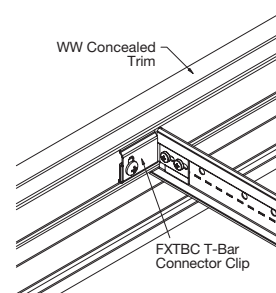

Step 4: Install Splice Plates

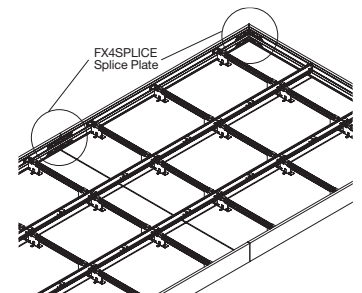

Step 5: Install Panels

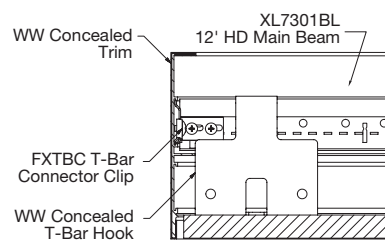
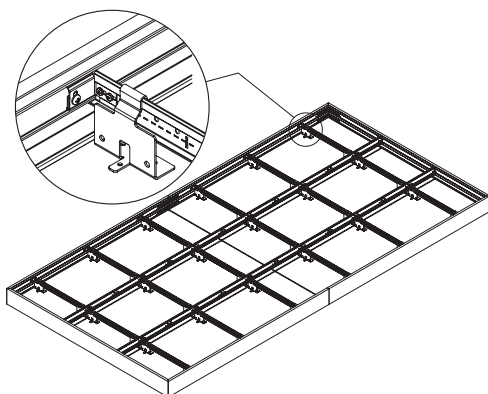



Additional Attributes of WoodWorks Linear Solid Wood Panels

- Two plank widths – nominal 3" and nominal 5" – in four rich finishes
- Fast, easy installation – screw into suspension system or install with backer clip
- Create continuous looks and clouds with solid wood trim
- Complete standard system from one manufacturer
- BioAcoustic™ infill available for increased acoustical performance
- Acoustical fleece available as an option



WoodWorks Linear Solid Wood panels in Grille Dark Cherry.

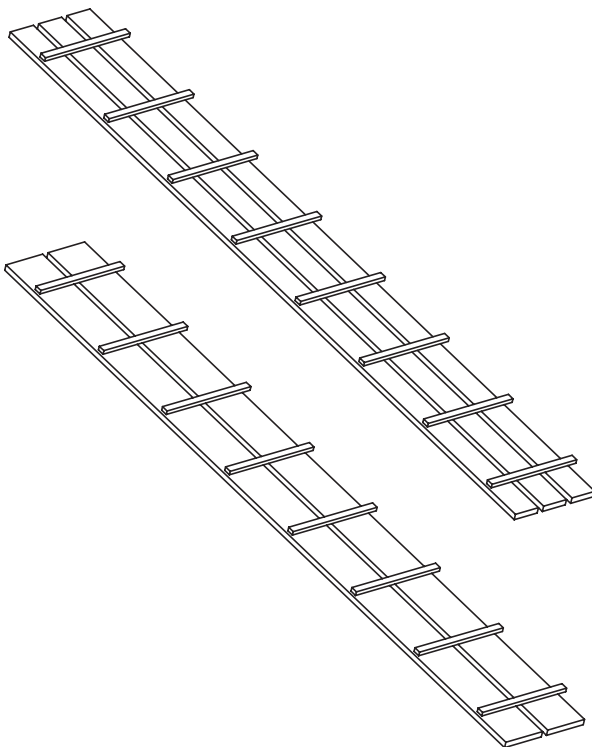

Finish Selection Due to printing limitations, shade may vary from actual product.



In addition to these standard options, there are more finish and size choices available as custom options. Contact the Armstrong Architectural Specialties project management team for details at 1 877 ARMSTRONG and select prompts 1-1-4.

LEED® Credits

Energy	Waste Mgmt	Recycled Content	Local Materials	Renewable Materials	Daylight & Views
			✓		
Location Dependent					

LEED for Schools

Acoustics	Low Emitting or CHPS
✓	



Finishes

Grille Maple (GMP)	Grille Dark Cherry (GDC)
Grille Light Cherry (GLC)	Grille Walnut (GWN)

Visual Selection

Performance Selection

Dots represent highest level of performance.

Edge Profile	Item Number *	Description	Dimensions† Nominal W x L x H	Acoustics NRC*
WOODWORKS Linear Solid Wood Panels				
	6693W1 _ _ _	Nominal 3" wide planks	1' x 8' x 3/4"	0.60
	6694W1 _ _ _	Nominal 5" wide planks	1' x 8' x 3/4"	0.50

* NRC achieved with acoustical infill (Item 6657).

NOTE: For additional color and size options, or acoustical felt available as a custom option, call Architectural Specialties at 1 877 ARMSTRONG and select options 1-1-4.

** When specifying or ordering, include the three-letter color suffix that coordinates with your WoodWorks ceiling: (e.g., 5671 G M P)

* When specifying or ordering, include the appropriate three-letter color suffix.

† Item 6693 – Features a total of 3 planks that are 3.25" wide with a 3/4" reveal between planks. Panels will have a 3/4" reveal on sides.

Item 6694 – Features a total of 2 planks that are 5.25" wide with a 3/4" reveal between planks. Panels will have a 3/4" reveal on sides.



Suspension Systems

15/16" Prelude® XL® (Black recommended)

Wood is a natural product and will exhibit natural variations in color, grain, and texture, and knot holes of up to 1/2" in diameter.



Accessories

Item Number	Description	Dimensions Nominal W x L x H	Color	Pieces/Carton
 7146 _ _ _ ♦	Solid Wood Trim	4" x 120" x 3/4"	See Finishes Above	Bulk
5687†	Backer Clip	3/8" x 11/16" x 7/8"	N/A	250 pcs/pail
 5671 _ _ _ ♦	Ledger	1" x 96" x 1/4"	See Finishes Above	Bulk
7891	12 Gauge Soft Hanger Wire	12' Length	N/A	140
92715A620	Self-tapping Screws	#2 x 3/4" Length	Black	25
6657	BioAcoustic™ Infill Panel	11" x 4' x 5/8"	Black (Matte)	10

♦ When specifying or ordering, include the three-letter color suffix that coordinates with your WoodWorks ceiling: (e.g., 5671 G M P)

† Backer clip should only be used when installing panels with 3" wide nominal planks.

Linear Solid Wood Panels Physical Data

Material

Planks and Backers – Solid Poplar (yellow or hybrid)

Surface Finish

Clear or tinted semigloss coating

Fire Performance

Solid Hardwood Blades and Backers – ASTM E84 surface burning characteristics. Flame Spread Index 200 or less. Smoke Developed Index 450 or less.

Class A intumescent treatment is available.

Fire performance will vary between wood species.

Composite Linear Solid Wood Panels product testing has not been completed, since results will vary on a project-by-project basis. Contact TechLine at 1 877 ARMSTRONG for details.

WoodWorks Linear Solid Wood Panels, as with other architectural features located at the ceiling, may obstruct or skew the planned fire sprinkler water distribution pattern, or possibly delay or accelerate the activation of the sprinkler or fire detection systems by channeling heat from a fire either toward or away from the device. Designers and installers are advised to consult a fire protection engineer, NFPA 13, and local codes for guidance where automatic fire detection and suppression systems are present.

Seismic Restraint

WoodWorks Linear Solid Wood Panels have been engineered, tested, and approved in all seismic areas.

Application Considerations

Variation among panels may occur due to the natural characteristics of the wood and grain.

Design Considerations

It is very important that WoodWorks panels are climatized prior to installation. Relative humidity between 25% and 55% and temperatures between 50°F and 86°F must be maintained.

Installation Consideration

System is designed to have a 1" gap between panels.

Backer clip can only be used for installations of the panel with 3" nominal planks (Item 6693)

Warranty

One (1) year limited warranty. Details: armstrong.com/warranty

Weight; Square Feet/Carton

6693 – 1.25 lbs/SF
6694 – 1.25 lbs/SF
(bulk packed)